

Calibre No. 2206A Basic Calibre 2205A 17J Catalog No. 22-05-1	Jewels 17j	Style Name
--	----------------------	------------



Cal. 2206A

Characteristics

Casing diameter: 17.20φ mm
 Maximum height: 5.85 mm
 Vibrations per hour: 28,800
 Automatic and auxiliary hand winding with sweep second
 Calendar (day & date)
 Instant setting device for day & date calendar
 Bilingual change-over system for day of week
 "Diashock" Shock Resistant Device

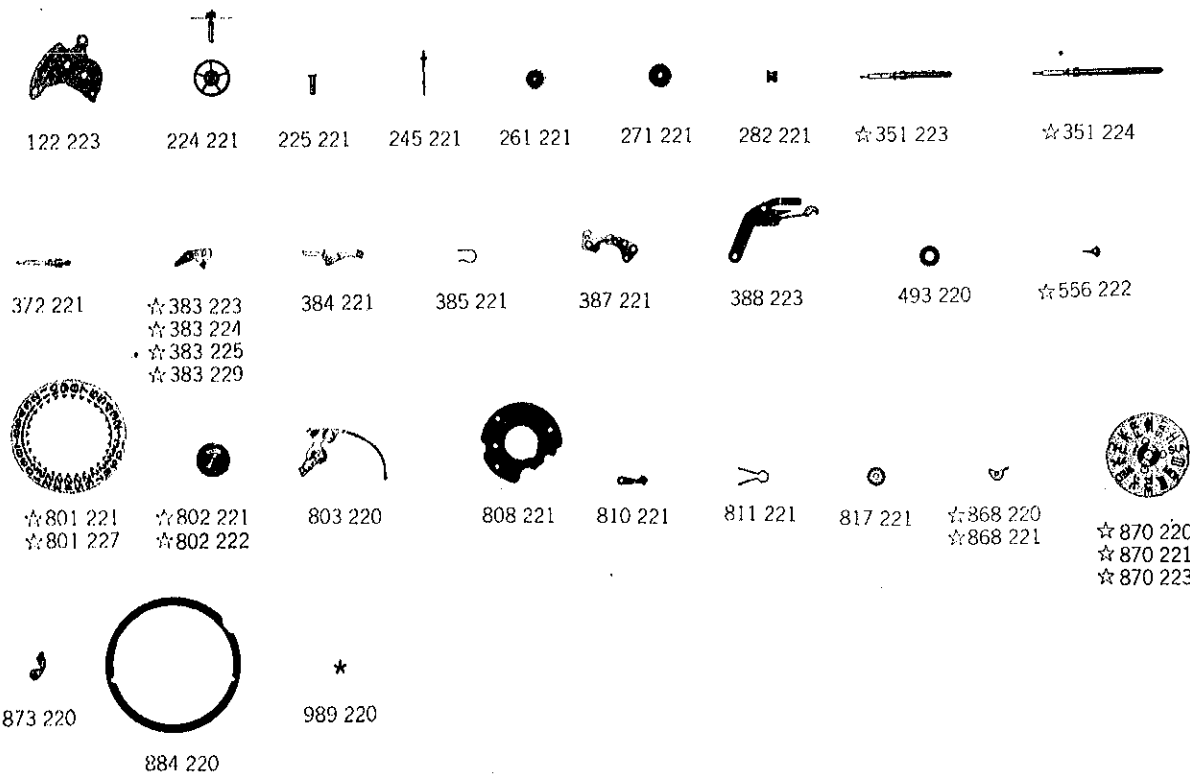

122 223 224 221 225 221 245 221 261 221 271 221 282 221 ☆351 223 ☆351 224

372 221 ☆383 223 ☆383 224 ☆383 225 ☆383 229 384 221 385 221 387 221 388 223 493 220 ☆556 222

☆801 221 ☆801 227 ☆802 221 ☆802 222 803 220 808 221 810 221 811 221 817 221 ☆868 220 ☆868 221 ☆870 220 ☆870 221 ☆870 223

873 220 884 220 989 220

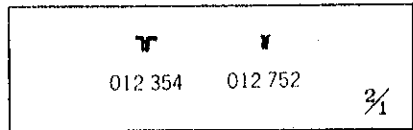

012 354 012 752 1/4

Catalog No. 22-06-1

Calibre No. 2206A Basic Calibre 2205A 17J Catalog No. 22-05-1	Jewels 17j	Style Name
--	----------------------	------------

PART NO.	LIST OF MATERIALS	PART NO.	LIST OF MATERIALS
112 224	Barrel & train-wheel bridge	☆801 221	Date dial
122 223	Center wheel bridge	☆801 227	Date driving wheel
161 221	Pallet cock	☆802 221	Setting wheel lever complete
171 221	Balance cock	☆802 222	Date dial guard
☆193 220	Framework for automatic device with ball-bearing	803 220	Date jumper
201 220	Complete barrel with arbor & mainspring	808 221	Date jumper spring
224 221	Center wheel & pinion with cannon pinion	810 221	Intermediate date wheel
225 221	Cannon pinion	811 221	Day finger
231 220	Third wheel & pinion	817 221	Day star with dial disk
241 220	Fourth wheel & pinion	☆868 220	Day jumper
245 221	Sweep second pinion	☆868 221	Holding ring for dial
251 220	Escape wheel & pinion	☆870 220	Intermediate wheel for day correction
261 221	Minute wheel	☆870 221	Stud screw
271 221	Hour wheel	☆870 223	Friction spring screw for sweep second pinion
282 221	Clutch wheel	873 220	Friction spring screw for intermediate pinion
283 221	Winding pinion	884 220	Pallet cock screw
284 220	Crown wheel	989 220	Balance cock screw
285 220	Ratchet wheel	012 121	Framework screw for automatic device with ball-bearing
301 110	Jewelled pallet fork & staff	012 129	Barrel & train-wheel bridge screw
310 221	Balance complete with stud	012 204	Center wheel bridge screw
315 220	Balance staff	012 263	Screw for setting wheel lever complete
331 110	Roller with jewel	012 279	Case screw
341 220	Regulator	012 280	Screw for oscillating weight
345 220	Stud holder	012 407	Click screw
☆351 223	Winding stem	012 422	Dial screw
☆351 224	Joint stem (movement portion)	012 668	Setting lever spring screw
372 221	Joint stem (case portion)	012 724	Screw for 1st reduction wheel click guard
373 250	Click	012 736	Date dial guard screw
381 220	Click spring	012 746	Minute wheel bridge screw
☆382 220	Setting lever	012 750	Upper hole jewel for center wheel
☆383 223	Yoke (Clutch lever)	012 752	Lower hole jewel for center wheel
☆383 224	Yoke spring (Clutch lever spring)	011 521	Upper hole jewel for 3rd wheel
☆383 225	Minute wheel bridge	011 521	Lower hole jewel for 3rd wheel
☆383 229	Setting lever spring	011 521	Upper hole jewel for 4th wheel
384 221	Setting lever axle	011 528	Upper hole jewel for escape wheel
385 221	Friction spring for sweep second pinion	011 528	Lower hole jewel for escape wheel
387 221	Crown wheel ring	011 528	Lower hole jewel for sweep second pinion
388 223	Dial washer	011 713	Upper hole jewel for pallet
390 221	Hour wheel ring	011 505	Lower hole jewel for pallet
☆396 221	Setting lever axle ring	013 014	Tube for barrel & train-wheel bridge screw
481 220	Diashock upper frame	013 015	Tube for center wheel bridge screw (long)
491 180	Diashock lower frame	013 016	Tube for screw of setting wheel lever complete
493 220	Diashock hole jewel with frame	013 022	Tube for center wheel bridge screw (short)
768 220	Diashock cap jewel	013 023	Tube for setting lever spring screw
014 603	Diashock spring		
014 604	Oscillating weight		
014 605	First reduction wheel		
011 221	Second reduction wheel		
014 317	Friction spring for intermediate pinion		
500 221	Rocking seat for idle wheel (with wheels)		
511 220	First reduction wheel click guard		
514 220	First reduction wheel click		
530 220	Click spring for first reduction wheel		
☆542 221	Intermediate pinion for ratchet wheel		
546 220	Date finger		
551 220			
553 220			
860 220			
☆556 221			
☆556 222			

☆⇒ Please see remarks on the next page.
 As for all other parts not shown here, please refer to the basic calibre
 (Cal. No. 2205A 17J Catalog No. 22-05-1 Red page).

☆⇒ Please see remarks on the next page.
 Items in light letters are not shown in photos; those parts are interchangeable with the basic calibre
 (Cal. No. 2205A 17J Catalog No. 22-05-1 Red page).

Calibre No.	2206A	Jewels	17j	Style Name	
⇒ Basic Calibre 2205A 17J Catalog No. 22-05-1					

Remarks :

Framework for automatic device with ball-bearing

☆ 193 220.....Some movements use the separate parts—Framework for automatic device (Part No. 191 220), Ball-bearing complete (Part No. 821 220) and Screw for ball-bearing complete (Part No. 012 751)—set up as unit. But the above parts can also be replaced by our more convenient part (Part No. 193 220) which unites the above three parts as single unit serving the purpose of the previous three separable parts.

Winding stem ———Refer to the photograph on the front page and shapes in the lower diagram. ———

☆ 351 223.....**Short** winding stem (Thread is provided completely on the crown portion.)
 ☆ 351 224.....**Long** winding stem (Thread is provided only on the end of the crown portion.)



Click spring

☆ 382 220..... 382 110 click spring also acceptable.

Setting lever

There are four types of setting levers. They are used according to the structure of cases and types of winding stems. Select a suitable one by the following procedures referring to the shapes indicated in Fig. 1.

In case of a one-piece water-resistant case, if an incorrect setting lever for dial diameter is used, the winding stem cannot be pulled out or the movement cannot be set in the case. Attention must be paid to this point. (Refer to Fig. 2, Example of suitable setting lever)

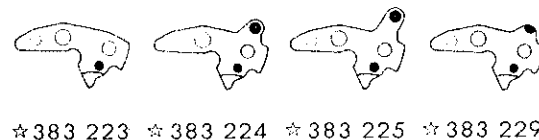

[Fig. 1]

☆ 383 223.....Used for watch with joint stem, or with ordinary winding stem other than one-piece or square type water-resistant case.

☆ 383 224.....Used for one-piece water-resistant case with ordinary winding stem and dial of diameter 17.50—18.00φ mm.

☆ 383 225.....Used for one-piece water-resistant case with ordinary winding stem and dial of diameter 18.50—19.00φ mm.

☆ 383 229.....Used for one-piece water-resistant case with ordinary winding stem and dial of diameter less than 17.00φ mm.

When parts number of the setting lever is unknown or when ordering setting levers other than the above, specify ① Cal. No. ② jewels ③ dial No. and ④ case No.

[Fig. 2]

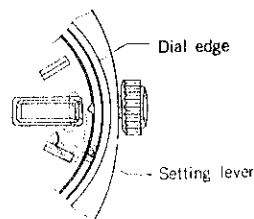

[Example of suitable setting lever] Tail of the setting lever is located between the dial and the case.

Friction spring for sweep second pinion

☆ 396 221..... 396 110 friction spring for sweep second pinion also acceptable.

Rocking seat for idle wheel (with wheels)

☆ 542 221.....Rocking seat for idle wheel (Part No. 542 220) and Idle wheels (2 pcs., Part No. 508 220) are set jointly or sometimes set separately.

☆ 542 221 set in joint with Rocking seat and Idle wheels, can be used in common with the above two types when replacing (Refer to the right diagram).

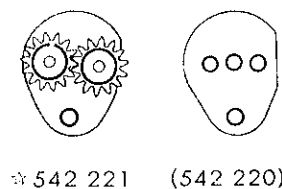

—continued on reverse page—

Calibre No.	2206A	Jewels	17j	Style Name	
⇒ Basic Calibre 2205A 17J Catalog No. 22-05-1					

Remarks : —continued—

Date dial

☆ 801 221.....Used when both the crown and the date frame are located at 3 o'clock position.
 ☆ 801 227.....Used when the crown is located at 3 o'clock position and the date frame at 6 o'clock position.

If the date dial is required in any other type, specify ① Cal. No. ② jewels ③ the crown position ④ the date frame position and ⑤ dial No.

Day star with dial disk

☆ 870 220(English ↔ Japanese).....Used when both the crown and the day frame are located at 3 o'clock position.
 ☆ 870 221(English).....Used when the crown is located at 3 o'clock position and the day frame at 6 o'clock position
 ☆ 870 223(English ↔ Japanese).....Used when the crown is located at 3 o'clock position and the day frame at 6 o'clock position.

If the day star with dial disk is required in any other type, specify the number printed on the disk.

Date finger, Date driving wheel and Day finger

Since these parts have two types each, use with the following combination. The parts No. differ according to the shape of the date driving wheel axle pivoting on the main plate. Select a suitable one by referring to the description below when replacing.

☆ 556 221(Date finger=silver colour)
 ☆ 802 221(Date driving wheel=silver colour)
 ☆ 868 220(Day finger=silver colour) } Used only when the date driving wheel axle pivoting on the main plate is without eccentric post.
 ☆ 556 222(Date finger=gold colour)
 ☆ 802 222(Date driving wheel=gold colour)
 ☆ 868 221(Day finger=gold colour) } Used only when the date driving wheel axle pivoting on the main plate is with eccentric post.

Refer to the following diagram as to distinguish and combine each parts.

Main plate	(Date driving wheel axle)	Date driving wheel	Day finger	Date finger
	without eccentric post	 ☆ 802 221 (silver colour)	 ☆ 868 220 (silver colour)	 ☆ 556 221 (silver colour)
	with eccentric post	 ☆ 802 222 (gold colour)	 ☆ 868 221 (gold colour)	 ☆ 556 222 (gold colour)

(1) Specifications

Casing diameter	17.20 mm
Height	5.85 mm
Vibrations per hour	28,800 (8 beats per second)
Automatic winding	(with auxiliary hand winding mechanism)
Idle wheel system	Day & date, Bilingual changeover mechanism for day indication
Calendar	With instant day and date setting mechanism (crown revolving system)

(2) Features

A new model with the week days plus the instant day and date setting mechanism added to the existing Calibre 2205. The numbers of parts are reduced, adequately considering easy disassembling and assembling operations and stabilized functions. Regarding the automatic winding mechanism, it adopts an idle wheel system, rendering the mechanism excellent in abrasion resistant and shock resistant characteristics; the winding ability is also stabilized. Since the automatic winding mechanism can be separated from other mechanisms, an independent assembly of the automatic winding mechanism is possible, enabling this mechanism alone to be installed on the movement main body. On the other hand, by adopting an unusual simple clutch mechanism, hand winding of the mainspring is smoothly achieved.

(3) Disassembly and assembly

Refer to calibre 2202A for the train wheel and regulator mechanism; refer to calibre 2205A for the automatic winding mechanism. As for the calendar setting mechanism, disassemble it according to Figs. (1) - (33). Assemble in reverse order to the above procedures, Figs. (33) - (1), paying attention to the comments on the diagrams.

(4) Lubrication

The following colored symbols in the illustrated figures indicate the types of oil, quantities to be applied and lubricating points. (Always comply with indications in the figures for lubrication).

Types of oil	Oil quantity
Moebius A	●●● Sufficient quantity
Seiko watch oil S-4	●● Normal quantity
	● Extremely small quantity

Other points requiring lubrication, in addition to the above symbols are separately indicated. Apply oil correctly.

Note: Unindicated portions do not require lubrication.

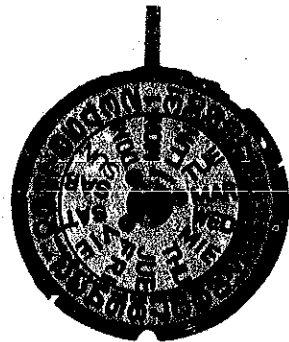
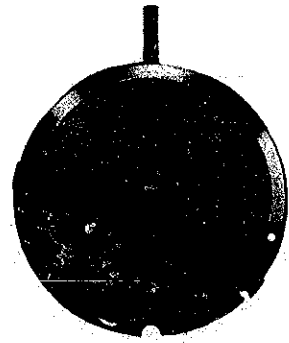

Movement

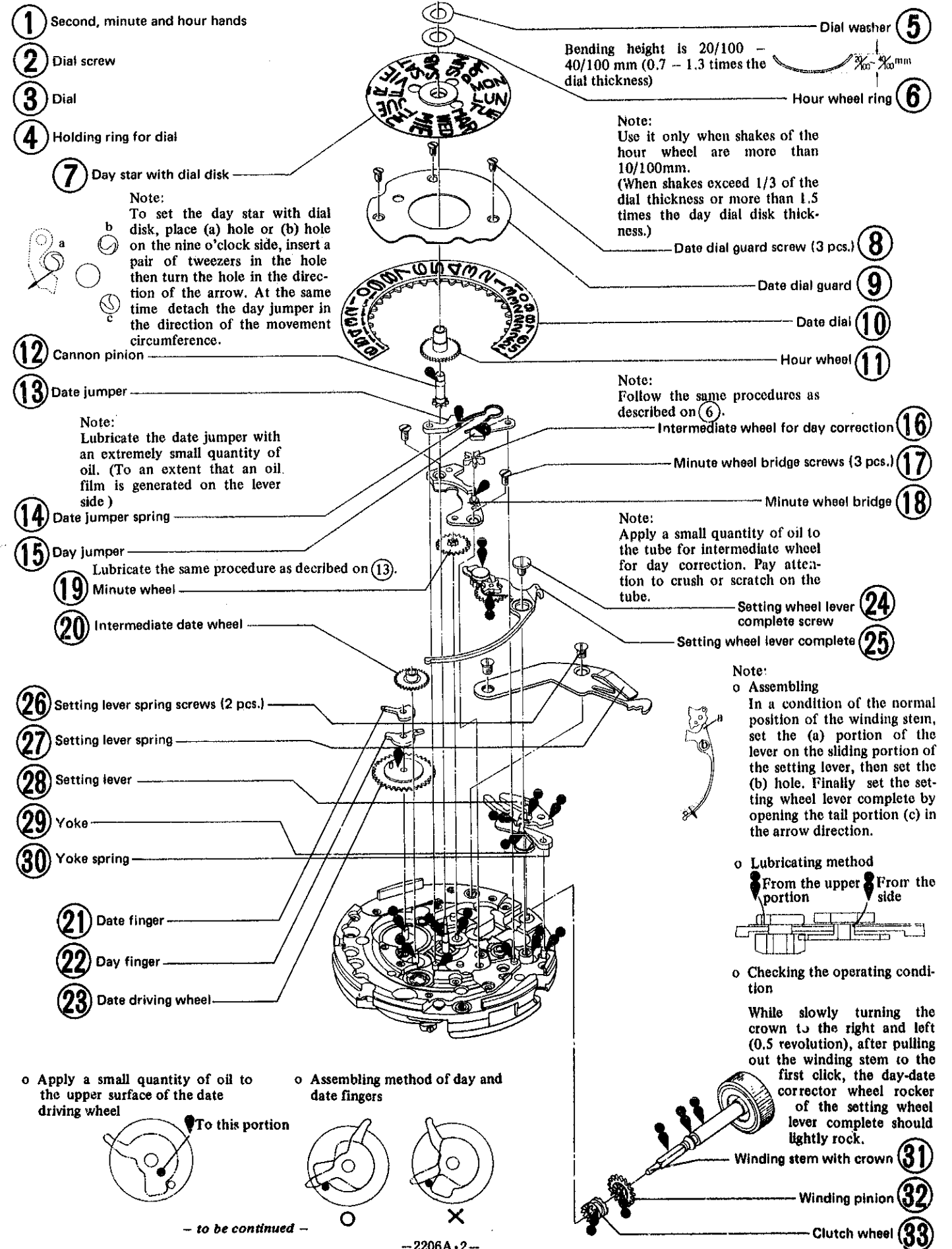

- to be continued -

2206A CALENDAR, SETTING MECHANISM - Continued

- continued -

o Shapes of the day and date fingers and date driving wheel have been modified. In replacing them during repair, select the correct parts according to the following combination and dividing method.

*556221 (Date finger = Silver colour)
*802221 (Date driving wheel = Silver colour)
*868220 (Day finger = Silver colour)

Use only when the tube for date driving wheel screw pivoting on the main plate without eccentric post.

*556222 (Date finger = Gold colour)
*802222 (Date driving wheel = Gold colour)
*868221 (Day finger = Gold colour)

Use only when the tube for date driving wheel screw pivoting on the main plate with eccentric post.

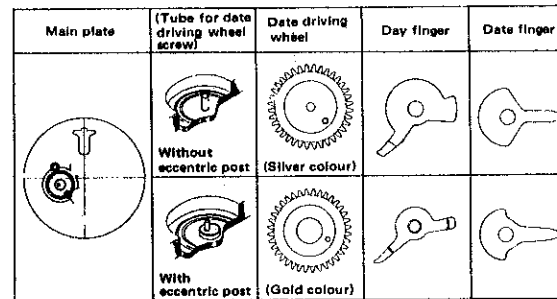

2206A SETTING MECHANISM

Crown normal position (winding the mainspring) - Fig. 8

The mainspring can be wound by revolving the crown when the winding pinion gears with the clutch wheel.

Position where the crown is pulled out to the first click (Setting day and date) - Fig. 9

When the clutch wheel and the setting wheel are geared, turn the crown clockwise and the date dial is forwarded. Turn the crown counterclockwise, then the day star can be quickly forwarded.

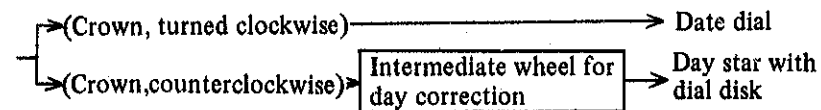
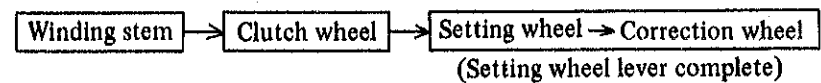

Position where the crown is pulled out to the second click (Setting time) - Fig. 10

As the setting wheel lever complete is pushed by the setting lever, the clutch wheel, the setting wheel and the minute wheel are meshed with one another, and at this position, turn the crown to set the hands.

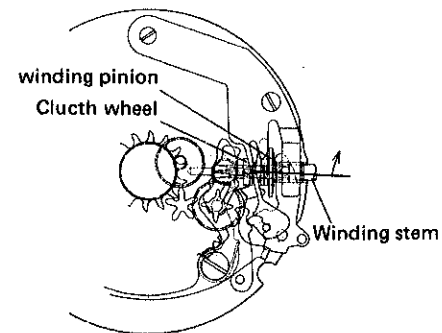
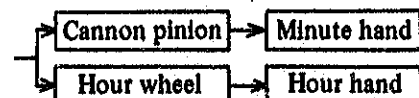
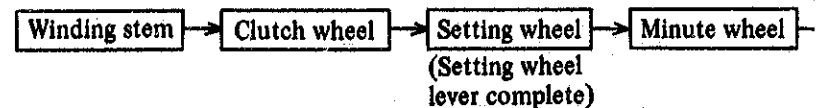

Fig. 8

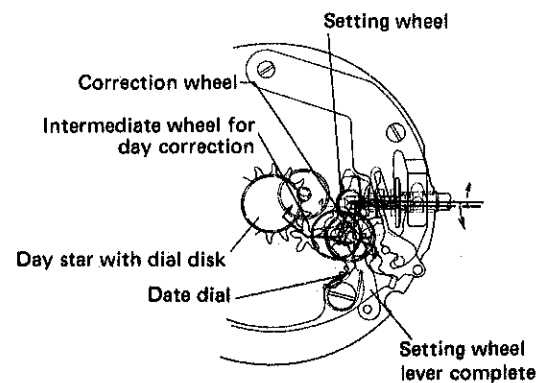

Fig. 9

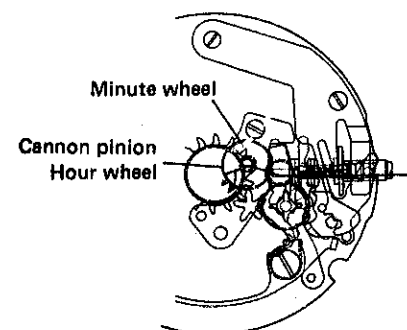

Fig. 10