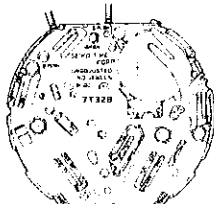
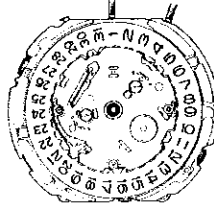

PARTS CATALOGUE / TECHNICAL GUIDE

Cal. 7T32B

Cal. 7T42B

[SPECIFICATIONS]

Item		Cal. No.	7T32B	7T42B		
Movement						
			The illustrations refer to Cal. 7T32B. (x 1.0)			
Movement size	Outside diameter		ø27.6mm 24.0mm between 3 o'clock and 9 o'clock sides			
	Casing diameter		ø27.0mm 24.0mm between 3 o'clock and 9 o'clock sides			
	Height		3.2mm			
Time indication			Main time	Stopwatch	Alarm	Timer (for Cal. 7T42B)
			Hour, minute and small second hands	Minute and 1/5-second hands	Small hour and minute hands	Minute and second hands (Stopwatch 1/5-second and minute hands)
Driving system			Step motor, 4 pieces			
Additional mechanism			<ul style="list-style-type: none"> • Electronic circuit reset switch • Train wheel setting device • Battery life indicator (Small second hand moves at two-second intervals.) • Date calendar • Instant setting device for date calendar • Stopwatch function (Up to 30 minutes in 1/5 seconds) <ul style="list-style-type: none"> • Accumulated elapsed time measurement • Split time measurement • Timer function (Up to 60 minutes in minutes) • Alarm function (12-hour indication system) • Alarm test system 			
Loss/gain			Monthly rate at normal temperature range: less than 15 seconds			
Regulation system			Nil			
Measuring gate by quartz tester			Use 10-second gate.			
Battery			SEIKO SR927W, Maxell SR927W, SONY SR927W, EVEREADY 399 Battery life is approximately 2 years. Voltage: 1.55V			
Jewels			0 jewel			

SEIKO CORPORATION

PARTS CATALOGUE

Cal. 7T32B, 7T42B

Disassembling procedures Figs. : ① → ⑦⑨

Reassembling procedures Figs. : ⑦⑨ → ①

Lubricating: Types of oil

● Moebius A

∞ SEIKO Watch Oil S-6

∞ Silicone Oil 500,000 c.s.

Oil quantity

∞ Normal quantity

∞ Extremely small

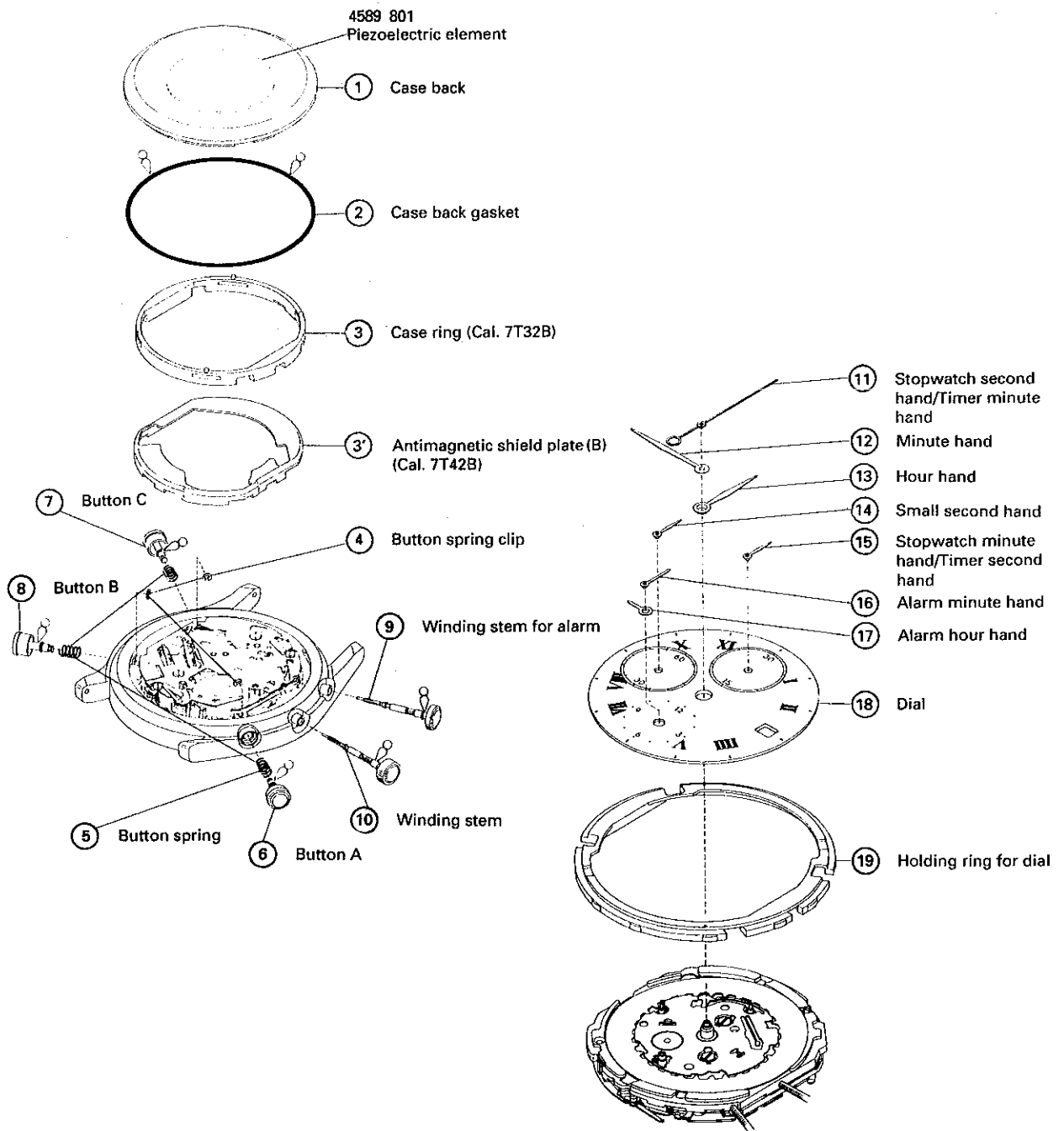

○ → Please see the remarks on the following pages.

PARTS CATALOGUE

Cal. 7T32B, 7T42B

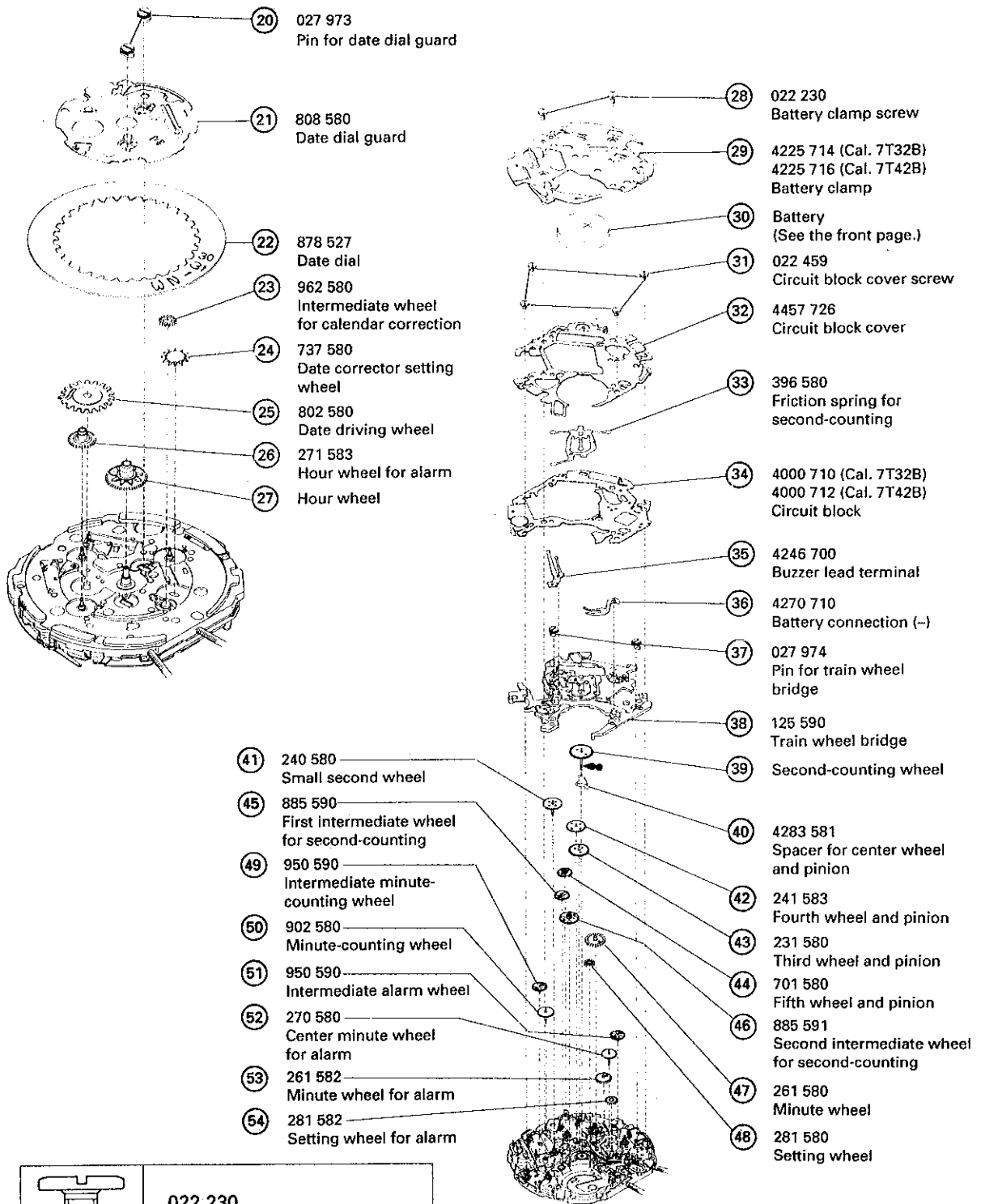

- 20 027 973
Pin for date dial guard
- 21 808 580
Date dial guard
- 22 878 527
Date dial
- 23 962 580
Intermediate wheel
for calendar correction
- 24 737 580
Date corrector setting
wheel
- 25 802 580
Date driving wheel
- 26 271 583
Hour wheel for alarm
- 27 Hour wheel

- 28 022 230
Battery clamp screw
- 29 4225 714 (Cal. 7T32B)
4225 716 (Cal. 7T42B)
Battery clamp
- 30 Battery
(See the front page.)
- 31 022 459
Circuit block cover screw
- 32 4457 726
Circuit block cover
- 33 396 580
Friction spring for
second-counting
- 34 4000 710 (Cal. 7T32B)
4000 712 (Cal. 7T42B)
Circuit block
- 35 4246 700
Buzzer lead terminal
- 36 4270 710
Battery connection (-)
- 37 027 974
Pin for train wheel
bridge
- 38 125 590
Train wheel bridge
- 39 Second-counting wheel
- 40 4283 581
Spacer for center wheel
and pinion
- 42 241 583
Fourth wheel and pinion
- 43 231 580
Third wheel and pinion
- 44 701 580
Fifth wheel and pinion
- 46 885 591
Second intermediate wheel
for second-counting
- 47 261 580
Minute wheel
- 48 281 580
Setting wheel

- 41 240 580
Small second wheel
- 45 885 590
First intermediate wheel
for second-counting
- 49 950 590
Intermediate minute-
counting wheel
- 50 902 580
Minute-counting wheel
- 51 950 590
Intermediate alarm wheel
- 52 270 580
Center minute wheel
for alarm
- 53 261 582
Minute wheel for alarm
- 54 281 582
Setting wheel for alarm

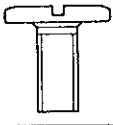
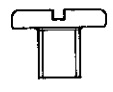
	022 230 Battery clamp screw
	022 459 Circuit block cover screw

○ ➔ Please see the remarks on the following pages.

PARTS CATALOGUE

Cal. 7T32B, 7T42B

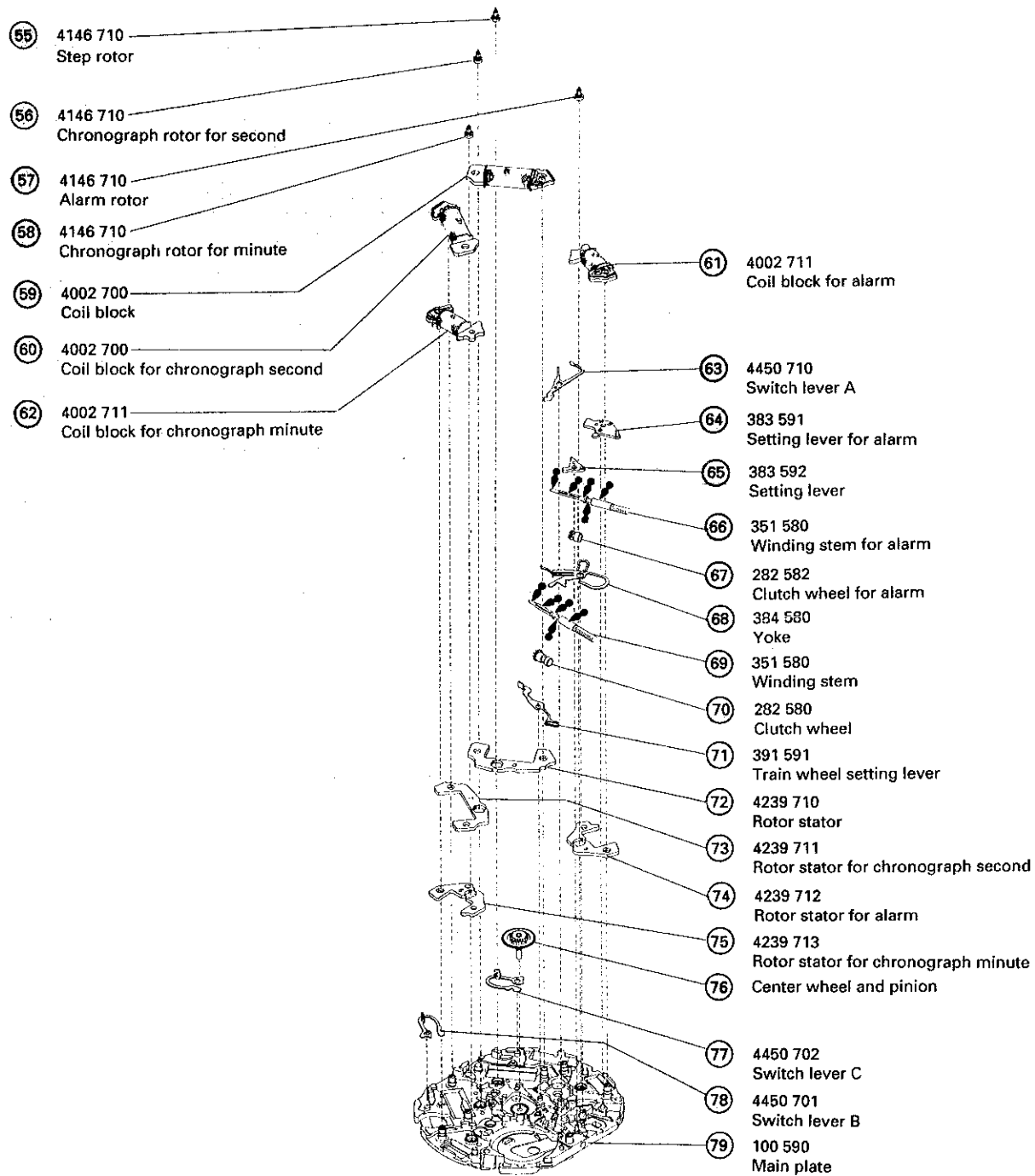

○ ➔ Please see the remarks on the following pages.

PARTS CATALOGUE

Cal. 7T32B, 7T42B

Remarks:

⑲ Holding ring for dial

The type of holding ring for dial is determined based on the design of cases.
Check the case number and refer to "SEIKO Casing Parts Catalogue" to choose a corresponding holding ring for dial.

⑳ Pin for date dial guard

㉓ Pin for train wheel bridge

For distinction between the pins, see the illustration below.

[Pin for date dial guard]



027 973

[Pin for train wheel bridge]

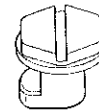

027 974

㉔ Date dial 878 527 (Black figures on white background)





The type of date dial is determined based on the design of cases.
Check the case number and refer to "SEIKO Casing Parts Catalogue" to choose a corresponding date dial.

㉗ Hour wheel

㉙ Second-counting wheel

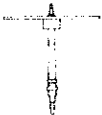
㉞ Center wheel and pinion

Combination

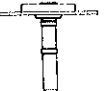
Parts name Type*	Hour wheel	Second-counting wheel	Center wheel and pinion
S	 271 580	 888 580	 221 580
M	 271 588	 888 582	 221 583

*Abbreviation (Movement type) S Short type M Standard type

PARTS CATALOGUE

Cal. 7T32B, 7T42B

34 Circuit block

To identify the circuit blocks for respective calibres, check the holes on the pattern as shown in the illustrations.

Cal. 7T42B

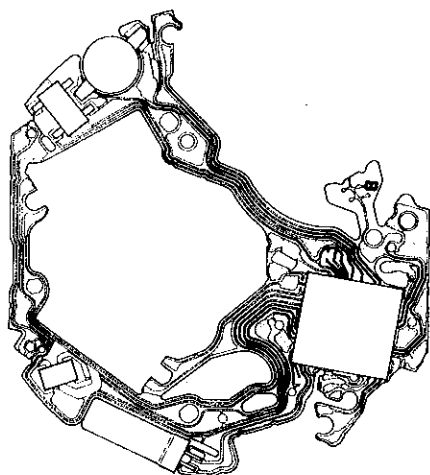

Cal. 7T32B

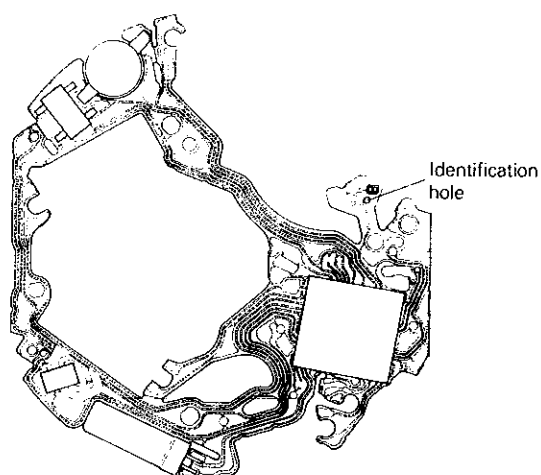

66 Winding stem for alarm

69 Winding stem

The type of winding stem for alarm and winding stem are determined based on the design of cases. Check the case number and refer to "SEIKO Casing Parts Catalogue" to choose a corresponding winding stem.

TECHNICAL GUIDE

Cal. 7T32B, 7T42B

- The explanation here is only for the particular points of Cal. 7T32B and 7T42B.
- For the repairing, checking and measuring procedures, refer to the "TECHNICAL GUIDE, GENERAL INSTRUCTIONS".

I. STRUCTURE OF THE CIRCUIT BLOCK

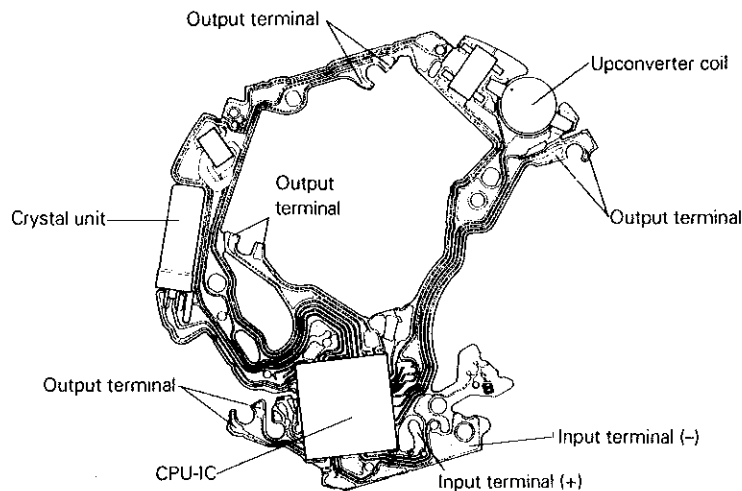

II. REMARKS ON INSTALLING THE BATTERY

- **A necessary step after installing the battery**
 - After the battery is replaced with a new one, or after the battery is re-installed following the repairing procedures, be sure to short-circuit the AC terminal and the circuit block cover with tweezers to reset the circuit as shown in the illustration below.

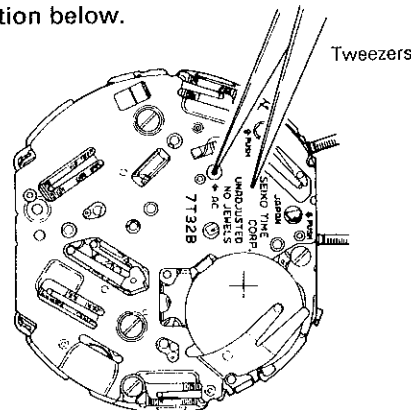

- After resetting the circuit, be sure to reset the stopwatch hands to the 12 o'clock position.

- 1) Pull out the crown at the 3 o'clock side to the second click.
- 2) Press button "B" to reset the stopwatch second hand to "0".
- 3) Press button "A" to reset the stopwatch minute hand to "0".

* With each press of buttons "B" and "A", the stopwatch second and minute hands move 0.2 seconds and 0.5 minutes, respectively. They move automatically while the buttons are kept pressed and stop when they are released.

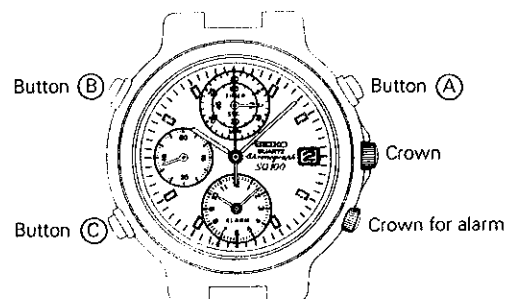

III. REMARKS ON DISASSEMBLING AND REASSEMBLING

⑨ Winding stem with crown for alarm

⑩ Winding stem with crown

• How to remove

- Winding stem with crown at the 3 o'clock side:

Pull out the crown to the first click, and then push the setting lever by inserting the tip of tweezers into hole "A" in the illustration below.

- Winding stem with crown for alarm at the 4 o'clock side:

Pull out the crown for alarm to the first click, and then push the setting lever for alarm by inserting the tip of tweezers into hole "B" in the illustration below.

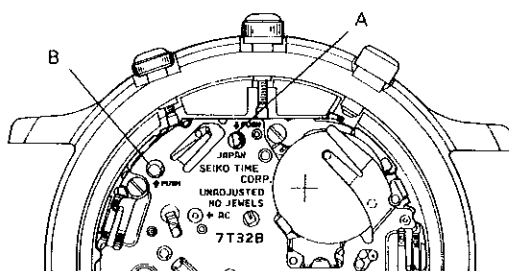

• Remarks on setting the winding stems

The winding stems at the 3 o'clock and 4 o'clock sides can be used interchangeably. However, note that the type of crown differs depending on the length of winding stem and the design of cases.

⑪ Stopwatch second hand

⑮ Stopwatch minute hand

• Remarks on installing

When installing those stopwatch hands, check that they accurately point to the stopwatch scales on the dial.

⑪ Stopwatch second hand

• Remarks on installing

After installing the hands, check that there is a proper clearance between the stopwatch second hand and other hands.

⑱ Dial

• Remarks on installing

When installing the dial, make sure that its center is securely set at the proper position.

TECHNICAL GUIDE

Cal. 7T32B, 7T42B

20 Pin for date dial guard

• How to remove

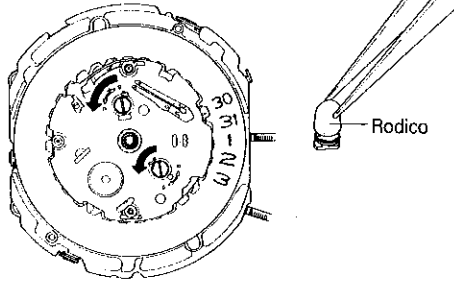

- 1) Turn the pins 90° counterclockwise to loosen them using a screwdriver.
- 2) Pick up the pins using rodico.

• How to install

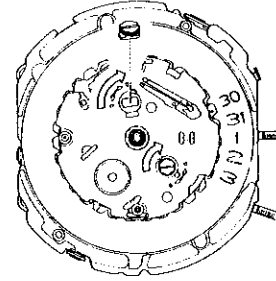

- 1) Set the pins properly into the grooves.
- 2) Turn the pins 90° clockwise using a screwdriver to fix them.

- Notes:**
- Never turn the pins more than 90° clockwise or counterclockwise.
 - Never apply undue force to the pins in turning them using a screwdriver.
 - Be sure to use a screwdriver that fits in with the slot of the pin head.

• Lubricating

Lubricate the date jumper and the tips of the date dial as shown in the illustration.

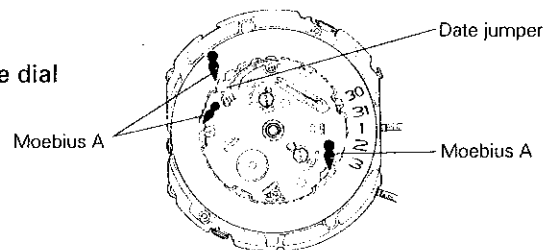

27 Hour wheel

• Remarks on installing

When installing the hour wheel, be sure to engage it securely with the pinion of the minute wheel.

29 Battery clamp

• How to install

Set the battery clamp securely to the guide tube, taking care not to press down the protruded portion of the circuit block cover.

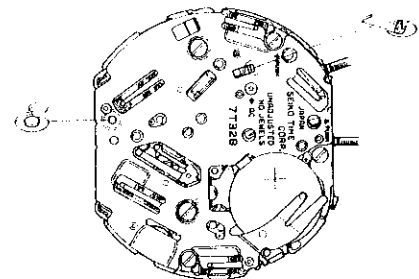

30 Battery

• Remarks on installing

After installing the battery, be sure to reset the circuit with tweezers as shown in the illustration.

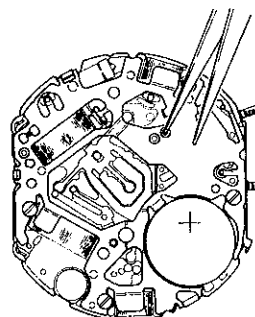

③② Circuit block cover

• How to remove

- 1) Loosen the four screws and remove them.
- 2) Release the click portion of the alarm yoke.
- 3) Release the three hooking portions of the circuit block cover by prying them up with the tip of a screwdriver as shown in the illustration at right.

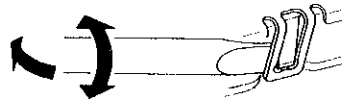

• Installing and lubricating

- 1) Set the hooking portion ①.
- 2) Check that the circuit block cover is securely set to the guide tube (a) and (b).
- 3) Set the hooking portions in the order of ② and ③ in the illustration.
- 4) Tighten the screw (c).
- 5) Hook the alarm yoke spring (d).
- 6) Tighten the other three screws.
- 7) Lubricate the click portion of the alarm yoke.

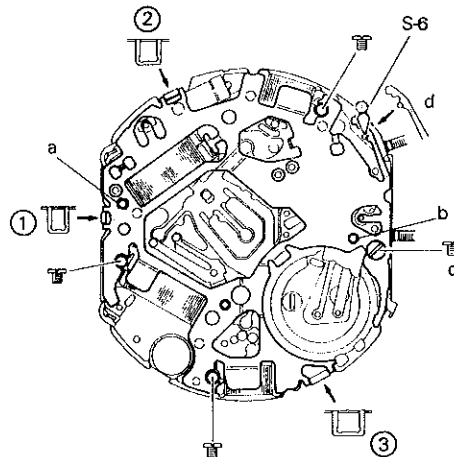

③③ Friction spring for second-counting

• Setting position

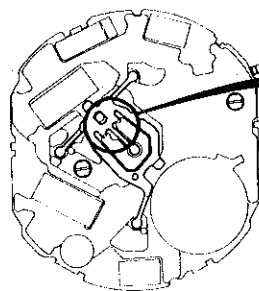

Enlarged



Slip the friction spring for second-counting into the gap under the train wheel bridge.

③④ Circuit block

• How to install

Set the guide holes (a ~ f in the illustration) of the circuit block securely onto the corresponding collars of the train wheel bridge.

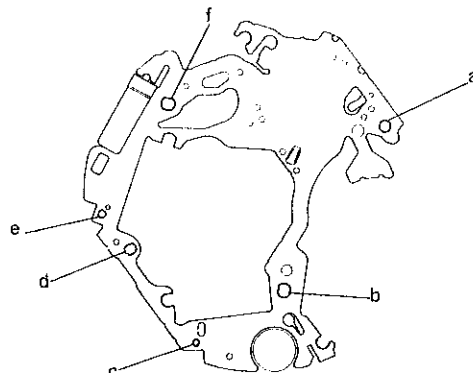

③⑦ Pin for train wheel bridge

• How to remove

Turn the pins 90° counterclockwise to loosen them, and pick them up using rodico.

• How to install

Set the pins properly into the groove as shown in the illustration, and turn them 90° clockwise with a screwdriver to fix them.

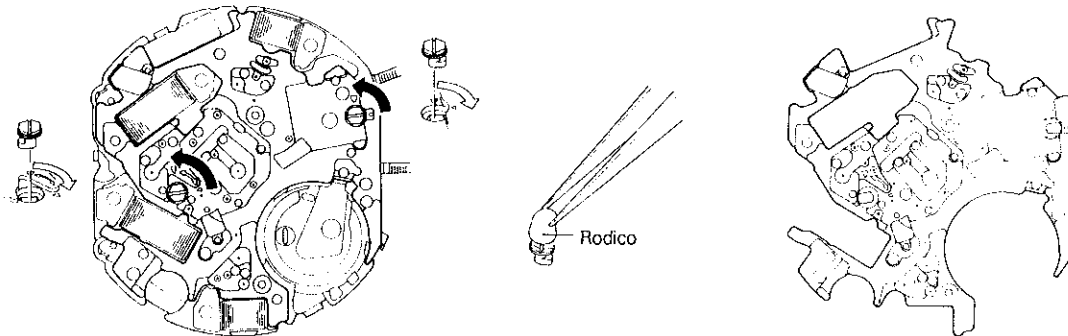

- Notes:**
- Never turn the pins more than 90° clockwise or counterclockwise.
 - Never apply undue force to the pins in turning them using a screwdriver.
 - Be sure to use a screwdriver that fits in with the slot of the pin head.

• Lubricating of the upper pivots for wheels and rotors

After installing the train wheel bridge, lubricate the step rotor, chronograph rotor for minute, alarm rotor, chronograph rotor for second, minute wheel, center minute wheel for alarm, second-counting wheel, minute-counting wheel and small second wheel.

③⑧ Train wheel bridge

• Remarks on installing

- Before installing the train wheel bridge, check if the wheels are set in the proper position, referring to the photograph below. Also, check their lower pivots are securely set in the axle holes.

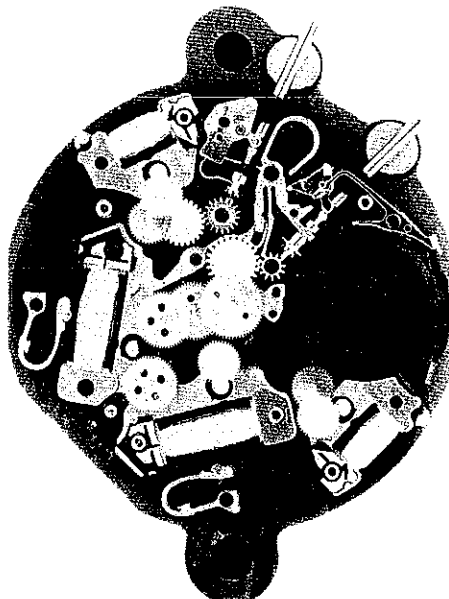

- Notes:**
- If the upper pivots cannot be set smoothly into the train wheel bridge, remove the train wheel bridge, check if the lower pivot of each wheel is set in the axle hole, and then set the train wheel bridge again.
 - * Do not press down the train wheel bridge forcibly as the axles of plastic wheels may be broken or be bent.
 - Note that some of the axle holes are not used, depending on calibres. For Cal. 7T32B and 7T42B, the axle holes indicated in the illustration are not used.

These axle holes are not used for Cal. 7T32B and 7T42B.

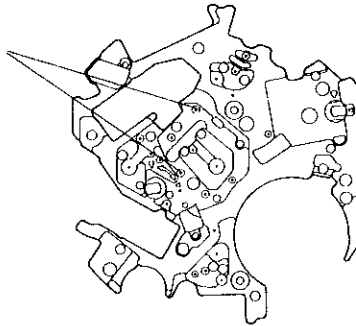

③⑨ Second-counting wheel ~ ⑤⑦ Setting wheel for alarm

After disassembling the wheels and rotors, arrange them as indicated in the illustration below to facilitate the reassembling procedures. However, the rotors should be kept separately from each other, as they emit magnetism.

[Reassembling procedures]

- Reassemble the parts below in the following order.
- * The reassembling order shown below is different from the one in the exploded view on pages 3 and 4.

- | | |
|---|--|
| <p>1 281 580
Setting wheel (Metal: silver)</p> <p>2 261 580
Minute wheel (Plastic: white)</p> <p>3 281 582
Setting wheel for alarm (Metal: silver)</p> <p>4 261 582
Minute wheel for alarm (Plastic: white)</p> <p>5 4146 710
Alarm rotor (Plastic: white)</p> <p>6 270 580
Center minute wheel for alarm (Metal: gold)</p> <p>7 950 590
Intermediate alarm wheel (Plastic: white)</p> <p>8 4146 710
Chronograph rotor for minute (Plastic: white)</p> <p>9 902 580
Minute-counting wheel (Metal: gold)</p> <p>10 950 590
Intermediate minute-counting wheel (Plastic: white)</p> | <p>11 4146 710
Chronograph rotor for second (Plastic: white)</p> <p>12 885 591
Second intermediate wheel for second-counting (Plastic: green)</p> <p>13 885 590
First intermediate wheel for second-counting (Plastic: white)</p> <p>14 4146 710
Step rotor (Plastic: white)</p> <p>15 701 580
Fifth wheel and pinion (Plastic: green)</p> <p>16 240 580
Small second wheel (Metal: gold)</p> <p>17 231 580
Third wheel and pinion (Metal: gold)</p> <p>18 241 583
Fourth wheel and pinion (Metal: gold)</p> <p>19 4283 581
Spacer for center wheel and pinion (Metal: silver)</p> <p>20 888 580
Second-counting wheel (Metal: gold)</p> |
|---|--|

TECHNICAL GUIDE

Cal. 7T32B, 7T42B

• **Setting position**

See the illustration below.

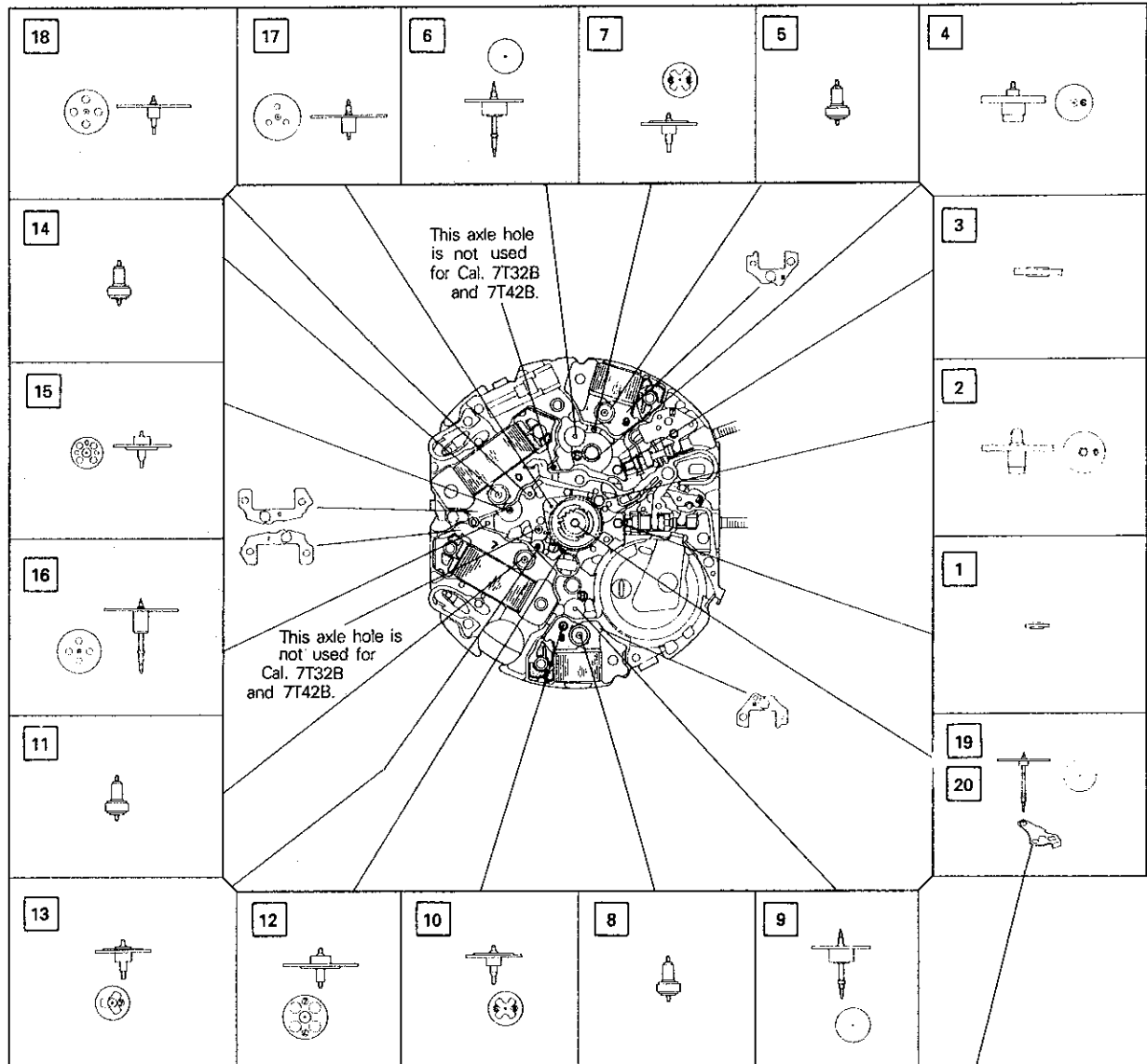

Reassembling Procedures Figs. : **1** ~ **20**

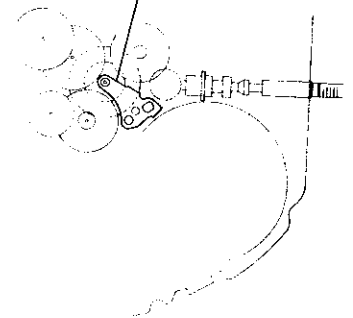

Notes:

1. The part code of the second-counting wheel differs depending on the installing height of hands.

Installing height of hands	Part code
Short type :	888 580
Standard type :	888 582

TECHNICAL GUIDE

Cal. 7T32B, 7T42B

2. The intermediate alarm wheel and the intermediate minute-counting wheel can be used interchangeably.
3. To distinguish between the minute-counting wheel and the minute wheel for alarm, note that the pinion gear of the minute wheel for alarm has teeth on it.
4. The numerals inscribed on the main plate, rotor stator and plastic wheels and pinions indicate the block No.

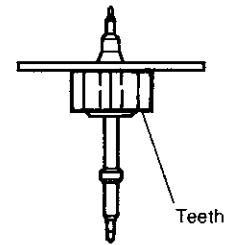

⑥③ Switch lever A ~ ⑦① Train wheel setting lever

• **Setting position and lubricating**

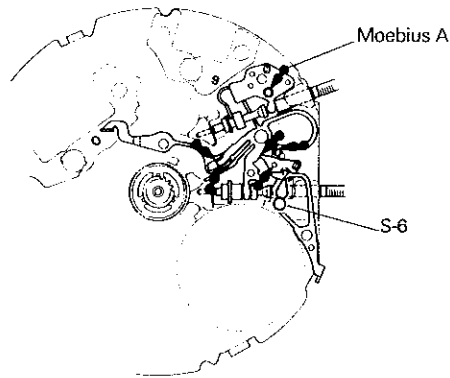

⑦⑥ Center wheel and pinion

• **Lubricating**

Lubricate the center wheel and pinion as shown in the illustration.

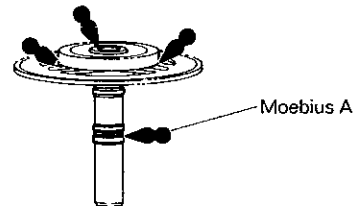

⑦⑦ Switch lever C ~ ⑦⑨ Main plate

• **Setting position**

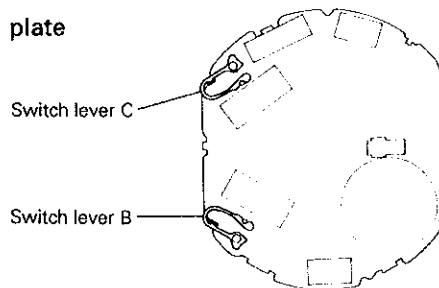

⑦⑨ Main plate

• **Lubricating**

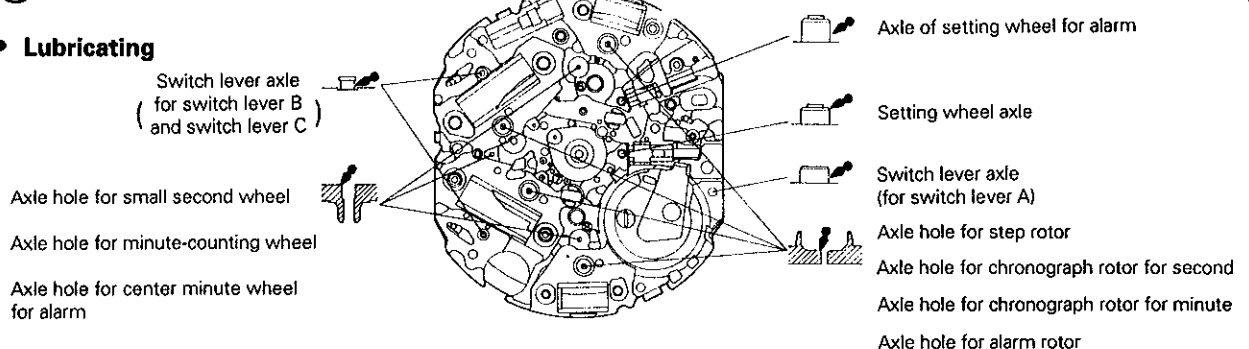

IV. VALUE CHECKING

- **Coil block resistance**

Coil block for alarm	:	1.8K Ω ~ 2.4K Ω
Coil block for chronograph minute	:	1.8K Ω ~ 2.4K Ω
Coil block for chronograph second	:	1.7K Ω ~ 2.3K Ω
Coil block	:	1.7K Ω ~ 2.3K Ω

- **Upconverter coil resistance:** 45 Ω ~ 60 Ω

- **Current consumption**

Before measuring current consumption, be sure to reset the circuit.

* Refer to "A necessary step after installing the battery".

For the whole of the movement

Time mode	:	less than 2.5 μ A
Stopwatch mode	:	less than 10.0 μ A

For the circuit block alone

Time mode	:	less than 1.8 μ A
-----------	---	-----------------------

- **Time accuracy**

When measuring the accuracy, make sure that the crown for alarm (at the 4 o'clock side) is at the first or second click position.

V. CHECKING OF THE FUNCTIONS

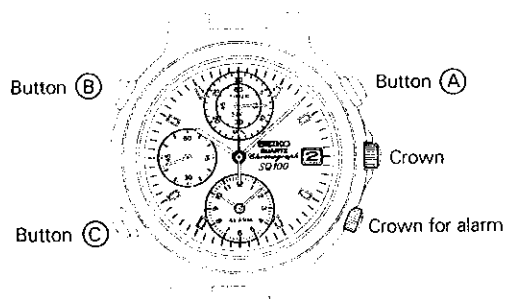

- **Ø-reset adjustment of the chronograph hands**

- 1) Pull out the crown at the 3 o'clock side all the way to the second click.
- 2) Keep buttons "A" and "B" pressed at the same time for more than 1 second.
- 3) Press button "B" to reset the stopwatch second hand to "0".
- 4) Press button "A" to reset the stopwatch minute hand to "0".

* With each press of buttons "B" and "A", the stopwatch second and minute hands move 0.2 seconds and 0.5 minutes, respectively. They move automatically while the buttons are kept pressed and stop if they are released.

• Checking of the stopwatch function

- 1) Push back both crown at the 3 o'clock side and crown for alarm at the 4 o'clock side in to the normal position.
- 2) Press button "A" repeatedly to check if the stopwatch hands start and stop with each press of the button.
- 3) Press button "A" to stop the stopwatch, and then, press button "B" to check if the stopwatch second and minute hands reset to "0"
- 4) Press button "A" to start the stopwatch second hand, and then, press button "B" to check if the stopwatch second hand stops. After that, press button "B" again to check if the stopwatch second hand automatically advances the time elapsed while it was stopped and resumes the measurement.

* If the crown at the 3 o'clock side is pulled out all the way to the second click while the stopwatch is in use, the measurement is stopped and the stopwatch second and minute hands return to "0". However, even if the crown is pulled out to the first click, the date setting will be made possible but the stopwatch does not stop measuring.

• Checking of the alarm function

- 1) Pull out the crown for alarm all the way to the second click and check if the warning sound beeps for one second. (The warning sound indicates that the designated alarm time has been canceled.)
- 2) Push the crown for alarm in to the first click from the second click, and check if the alarm sounds for approximately one minute.
- 3) Pull out the crown for alarm all the way to the second click to check the time indicated by the alarm hands, and then push it in to the first click. By doing so, the beeping sound continues. Press button "C" to stop it.
- 4) Press button "C" again to advance the alarm hands one minute ahead of the time you have checked.
- 5) Check if the alarm rings after one minute for 20 seconds and stops.

* The alarm is engaged when the crown for alarm is at the first click position. The crown at the 3 o'clock side has nothing to do with engagement/disengagement of the alarm.

• Checking of the timer function (only for Cal. 7T42B)

- 1) Pull out the crown for alarm to the first click. The warning beep may sound. In that case, press button "A", "B" or "C" to stop it.
- 2) Press button "B" twice to set the timer minute hand (stopwatch second hand) for "2 minutes".
- 3) Press button "A" to check if the timer starts counting down.
As "A" is pressed, the timer minute hand (stopwatch second hand) moves back one minute and the timer second hand (stopwatch minute hand) starts moving counterclockwise.
- 4) Check if, from one minute before the set time is up, the timer second hand stops and the timer minute hand moves counterclockwise at one-second intervals.
- 5) Check if the warning beep sounds once every second for 3 seconds before the set time is up.

* After the set time is up, the warning beep sounds for 2 seconds. While it is sounding, the second hand stops moving. When the beep stops, however, it starts moving again to indicate the current seconds, automatically making up for the time elapsed while it is stopped.